

HC

Ring blowers

*For Vacuum Pump or
Compressor Application*

บริษัท ไฮคอนโทรล จำกัด
โทร: 0-2073-7878



PRODUCT INTRODUCTION

Operating principle

The blower include an impeller and a side channel formed with a semi-circular side wall, having an inlet and outlet. As the impeller rotates, the air between the impeller blades is radially and circumferentially accelerated and pushed into the side channel. Here it is further compressed and forced back towards the impeller blades where the air is further accelerated. As air is transported along a spiral path through the impeller and side channel, each impeller blade increases the compression and acceleration until the air reaches the point where the side channel is connected to the discharge flange, where it is discharged. This type of blower is also referred to by other names such as Regenerative blower, Ring compressor, Side channel blower or Vortex blower.

The ring blower or exhauster increases the pressure of the aspirated gas by the creation, in the peripheral torodial channel, of a series of vortexes caused by the centrifugal thrust of the impeller.

While the impeller is rotating, the vanes force the gas forward and, because of the centrifugal thrust, outwards, producing a helical motion. During this motion, the gas is recompressed repeatedly with a consequent linear pressure increase along the length of the channel.

Applications and advantages

Ring blowers are suitable for all those applications requiring considerably higher pressures than that which can be achieved using centrifugal fans. Side channel exhausters are used in all those applications requiring an operating vacuum higher than the one achievable by a fan, but not as high as to require the use of a vacuum pump. The rotating parts are not in contact with the casing. There is therefore no friction during operation and thus no internal lubrication is necessary. The gas moving through the machine therefore remains uncontaminated and completely oil-free. The other main feature are:

- Beautiful surface
- Easy installation
- Low noise level
- No vibration and therefore complete dynamic stability
- Pulsation free discharge
- Minimal maintenance
- Higher pressure ratios
- Cooler running bearings
- Longer grease life
- Simple maintenance
- 100% oil free air
- Suitable to environment protection
- Small dimension





HC BLOWER type can be applied both as vacuum pump and compressor in continuous operation over the total stated performance curve range. The motors are available as standard for the input voltage range of 50 and 60 Hz and for protection category IP 54 as well as approved for CE and ROHS.

This motors are designed according to the DIN EN 60034 / IEC 34-1 and temperature class F.

For the three phase machines the tolerances +/- 10% for fixed voltage and for +/- 5% voltage range

The single phase machines are designed with a +/- 5% tolerances. If only 90% of the maximum allowed pressure will be used for continuous operating then

The allowed voltage range add to +/- 10%.

The frequency tolerances is maximum +/- 2%.

HC single stage ring blower models and performance (IP54 50/60 Hz three phase)

MODEL	Freq. Hz	Output power Kw	Voltage V	Rated current A	Max airflow m ³ /h	Max static suction mbar	Max static pressure mbar	Noise dB(A)	Weight Kg
RB010H06	50	0.2	200-240Δ/345-415 Y	1.0Δ/0.6 Y	40	-60	70	50	6
	60	0.23	220-275Δ/380-480 Y	1.0Δ/0.6 Y	50	-70	80	51	6
RB210-7AH16	50	0.4	200-240Δ/345-415 Y	2.6Δ/1.5 Y	80	-120	130	53	10
	60	0.5	220-275Δ/380-480 Y	2.6Δ/1.5 Y	98	-150	160	56	10
RB410-7AH16	50	0.85	200-240Δ/345-415 Y	4.0Δ/2.3 Y	145	-160	160	63	16
	60	0.95	220-275Δ/380-480 Y	3.85Δ/2.25 Y	175	-160	160	64	16
RB510-7AH26	50	1.6	200-240Δ/345-415 Y	7.5Δ/4.3 Y	210	-200	190	64	23
	60	2.05	220-275Δ/380-480 Y	7.6Δ/4.4 Y	255	-220	210	70	23
RB710-7AH16	50	2.2	200-240Δ/345-415 Y	9.7Δ/5.6 Y	318	-210	200	69	30
	60	2.55	220-275Δ/380-480 Y	10.3Δ/6.0 Y	376	-210	200	72	30
RB710-7AH26	50	3	200-240Δ/345-415 Y	12.5Δ/7.2 Y	318	-270	290	69	36
	60	3.45	220-275Δ/380-480 Y	12.6Δ/7.3 Y	376	-250	230	72	36
RB710-7AH37	50	4	345-415Δ/600-720 Y	9.0 Δ/5.2 Y	318	-290	330	69	40
	60	4.6	380-480Δ/660-720 Y	9.0 Δ/5.2 Y	376	-330	330	72	40
RB810-7AH17	50	5.5	345-415Δ/600-720 Y	12.9 Δ/7.4 Y	530	-300	300	70	63
	60	6.3	380-480Δ/660-720 Y	12.9 Δ/7.4 Y	620	-300	280	74	63
RB810-7AH27	50	7.5	345-415Δ/600-720 Y	16.7Δ/9.6 Y	530	-320	430	70	66
	60	8.6	380-480Δ/660-720 Y	17.3Δ/10.0 Y	620	-350	400	74	66

HC single stage ring blower models and performance (IP54 50/60 Hz single phase)

RB010A01	50	0.2	200-240V	1.43	40	-60	70	50	6
	60	0.23	200-240V	1.3	50	-70	80	51	6
RB210-7AA11	50	0.37	200-240V	2.7	80	-110	110	53	11
	60	0.45	200-240V	3.0	96	-130	140	56	11
RB410-7AA11	50	0.80	200-240V	5.2	145	-150	160	63	15
	60	0.90	200-240V	5.8	175	-160	140	64	15
RB510-7AA21	50	1.5	200-240V	9	210	-190	200	64	24
	60	1.75	200-240V	10.0	255	-180	180	70	24

RB 010 SERIES

Performance curve for vacuum pump

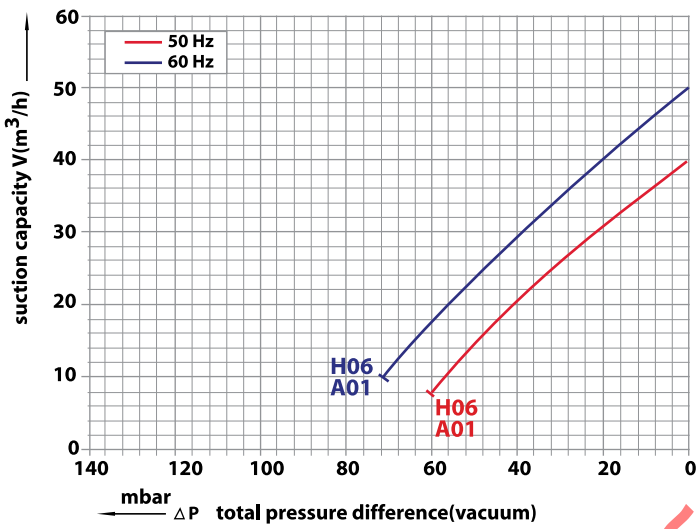

Performance curve for Compressor

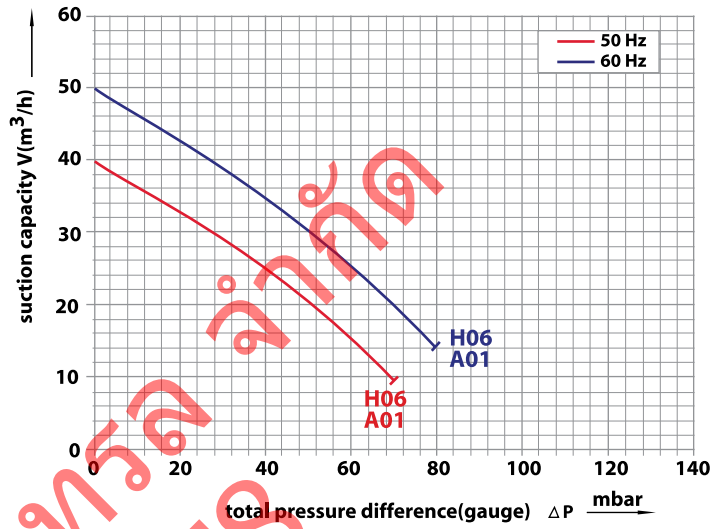

RB 210 SERIES

Performance curve for vacuum pump

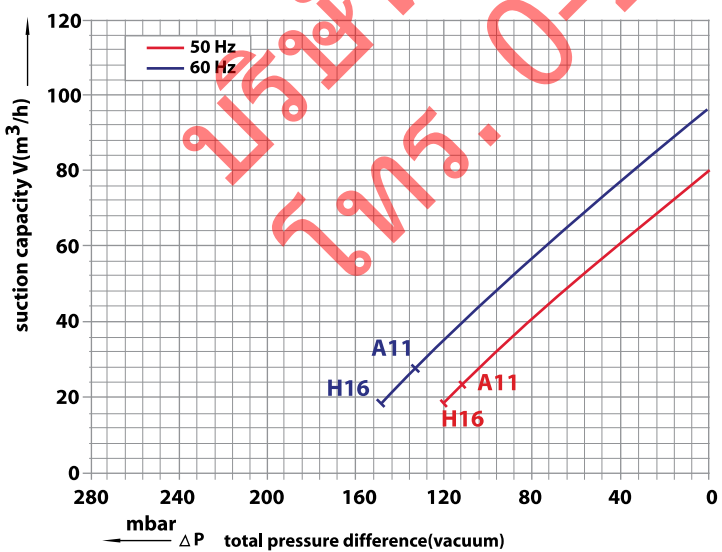

Performance curve for Compressor

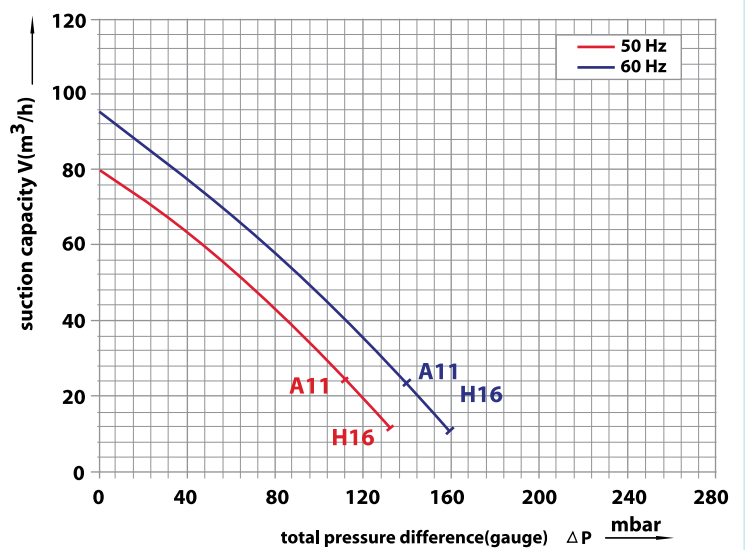

RB 410 SERIES

Performance curve for vacuum pump

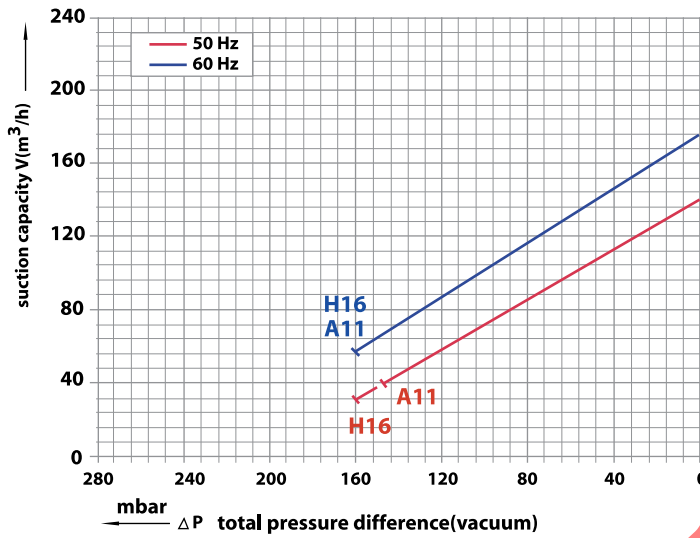

Performance curve for Compressor

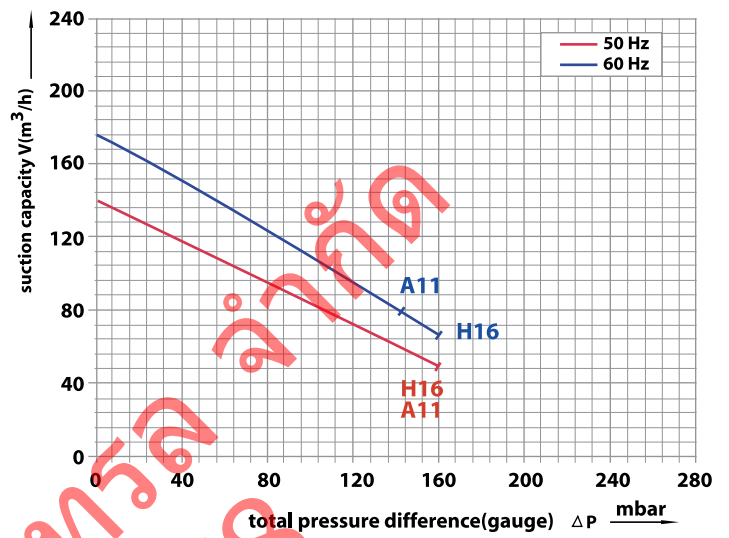

RB 510 SERIES

Performance curve for vacuum pump

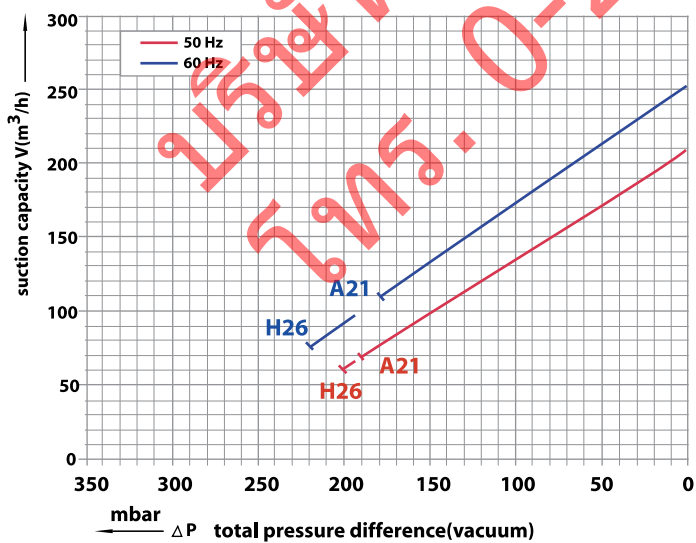

Performance curve for Compressor

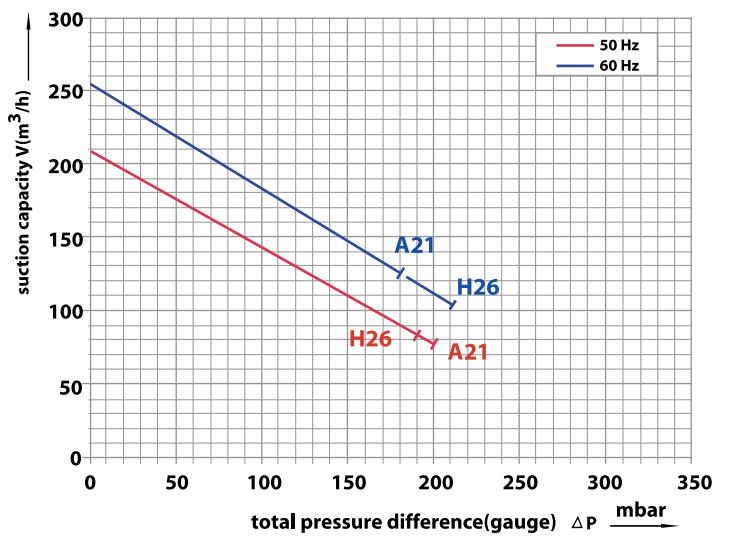

RB 710 SERIES

Performance curve for vacuum pump

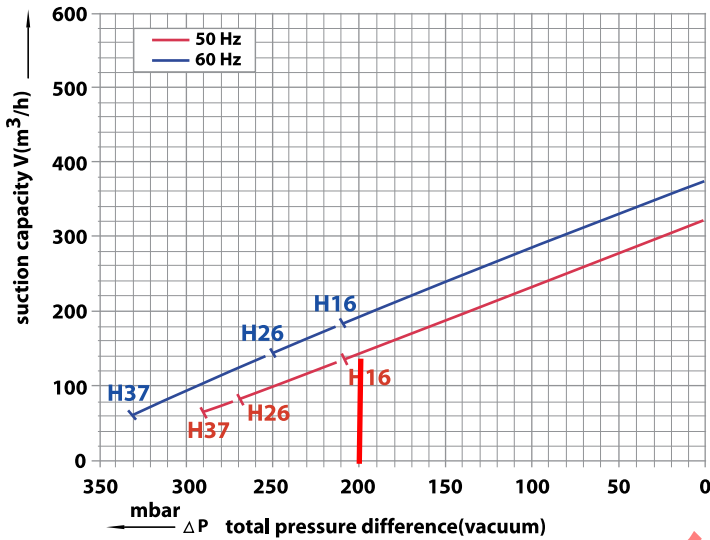

Performance curve for Compressor

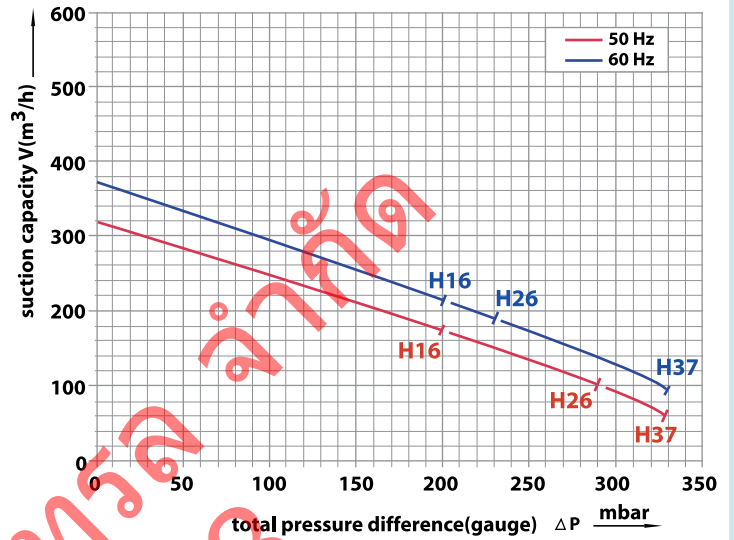

RB 810 SERIES

Performance curve for vacuum pump

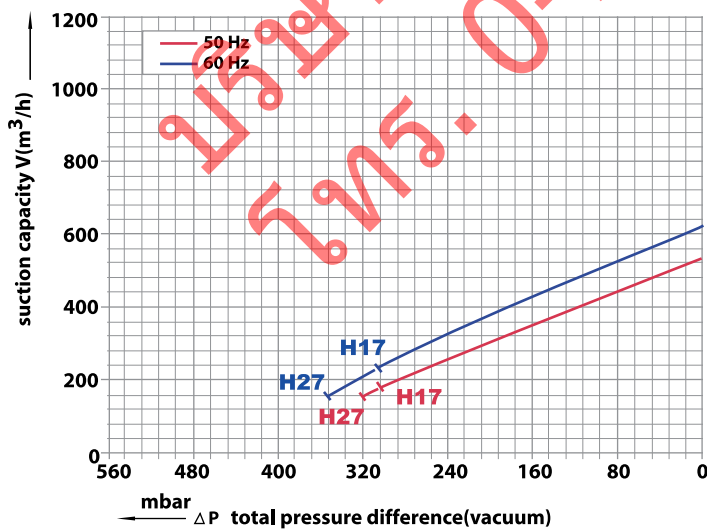

Performance curve for Compressor

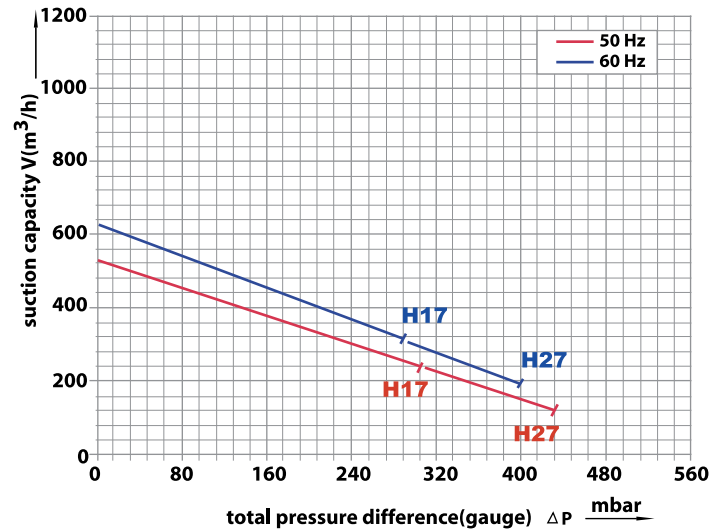

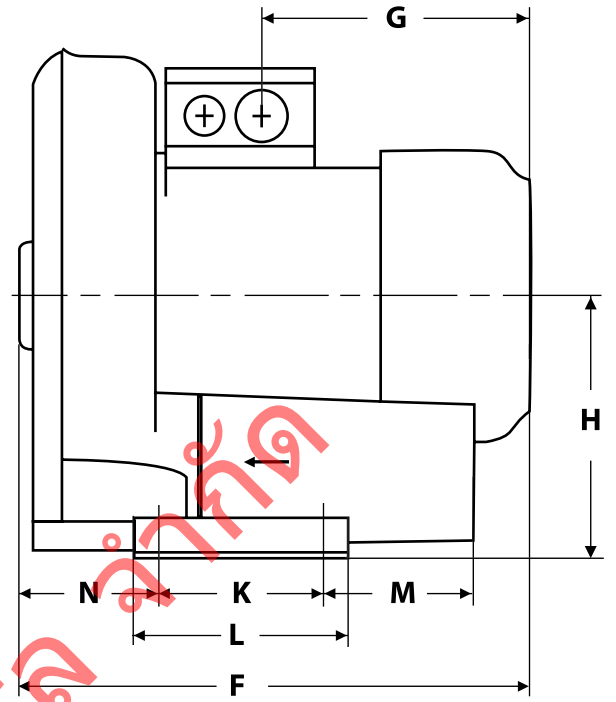
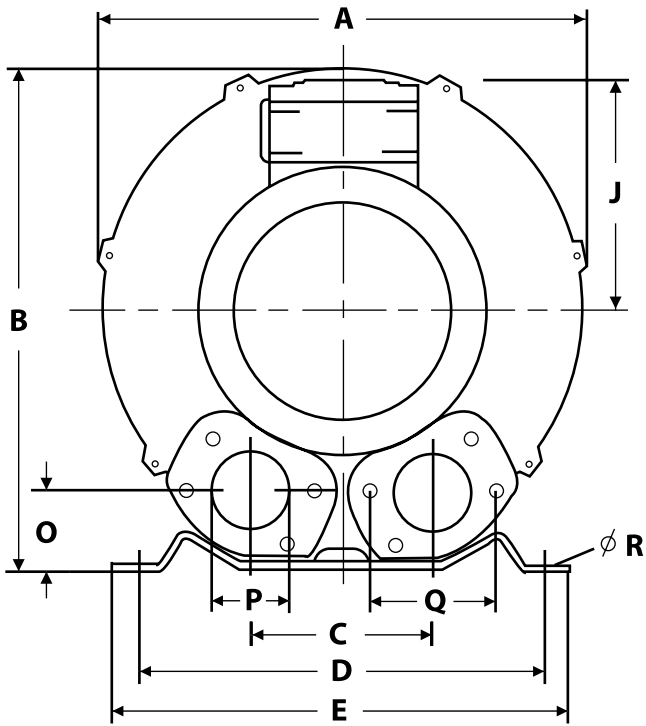

DIMENSION

MODEL	Phase	A	B	C	D	E	F	G	H	J	K	L	M	N	O	P	Q	ϕR
RB010A01	1	198	212	85	179	196	220	108	115	100	65	90	40	45	34	G1	60	8.5
RB010H06	3	198	212	85	179	196	220	108	115	100	65	90	40	45	34	G1	60	8.5
RB210-7AA11	1	246	247	90	205	230	256	133	128	111	83	108	75	71	39	G1¼	64	10
RB210-7AH16	3	246	247	90	205	230	256	129	128	111	83	108	75	71	39	G1¼	64	10
RB410-7AA11	1	285	302	115	225	255	292	156	154	120	95	130	70	75	46	G1½	68	12
RB410-7AH16	3	285	302	115	225	255	292	153	154	120	95	130	70	75	46	G1½	68	12
RB510-7AA21	1	334	337	120	260	295	346	188	175	128	115	155	96	87	48	G2	83	14
RB510-7AH26	3	334	337	120	260	295	346	185	175	128	115	155	96	87	48	G2	83	14
RB710-7AH16	3	382	384	125	290	325	377	185	198	128	140	180	84	109	54	G2	83	15
RB710-7AH26	3	382	384	125	290	325	411	190	198	135	140	180	84	109	54	G2	83	15
RB710-7AH37	3	382	384	125	290	325	432	211	198	148	140	180	84	109	54	G2	83	15
RB810-7AH17	3	451	461	152	356	394	477	222	240	167	170	216	140	124	65	G2½	94	15
RB810-7AH27	3	451	461	152	356	394	477	222	240	167	170	216	140	124	65	G2½	94	15