

Construction

Close-coupled, centrifugal pumps; electric motor with extended shaft directly connected to the pump.

NM: single-impeller

NMD: with two back-to-back impellers (with axial thrust balancing).

Connections: threaded ports ISO 228/1 (BS 2779).

Applications

- For clean liquids without abrasives, which are non-aggressive for the pump materials (solids content up to 0.2%).
- For water supply.
- For heating, air-conditioning, cooling and circulation plants.
- For civil and industrial applications.
- For fire fighting applications.
- For irrigation.

Operating conditions

Liquid temperature from -10 °C to +90 °C.

Ambient temperature up to 40° C.

Total suction lift up to 7 m.

Maximum permissible working pressure up to 10 bar (16 bar for pumps NMD 25/190; NMD 32/210; NMD 40/180).
Continuous duty.

Motor

2-pole induction motor, 50 Hz (n = 2900 rpm).

NM, NMD: three-phase 230/400 V ± 10% up to 3 kW;
400/690 V ± 10% from 4 to 9,2 kW;

NMM, NMDM: single-phase 230 V, with thermal protector.

Insulation class F.

Protection IP 54.

Constructed in accordance with IEC 34.

Special features on request

- Other voltages.
- Frequency 60 Hz (as per 60 Hz data sheet).
- Protection IP 55.
- Special mechanical seal
- Higher or lower liquid or ambient temperatures.

Materials

Components	NM, NMD	B-NM, B-NMD	I-NM, I-NMD
Pump casing	Cast iron	Bronze	Cr Ni Mo steel AISI 316
Lantern bracket	GJL 200 EN 1561	G-Cu Sn 10 UNI 7013	
Impeller	Brass P- Cu Zn 40 Pb 2 UNI 5705		
	NM 17	Cast iron GJL 200 EN 1561	Bronze G-Cu Sn 10 UNI 7013
Shaft	Cr steel AISI 430		Cr Ni Mo steel AISI 316
	Cr Ni steel AISI 303 1,1 -1,5 - 2,2 kW		
Mechanical seal	Carbon - Ceramic - NBR		

Coverage chart n ≈ 2900 rpm

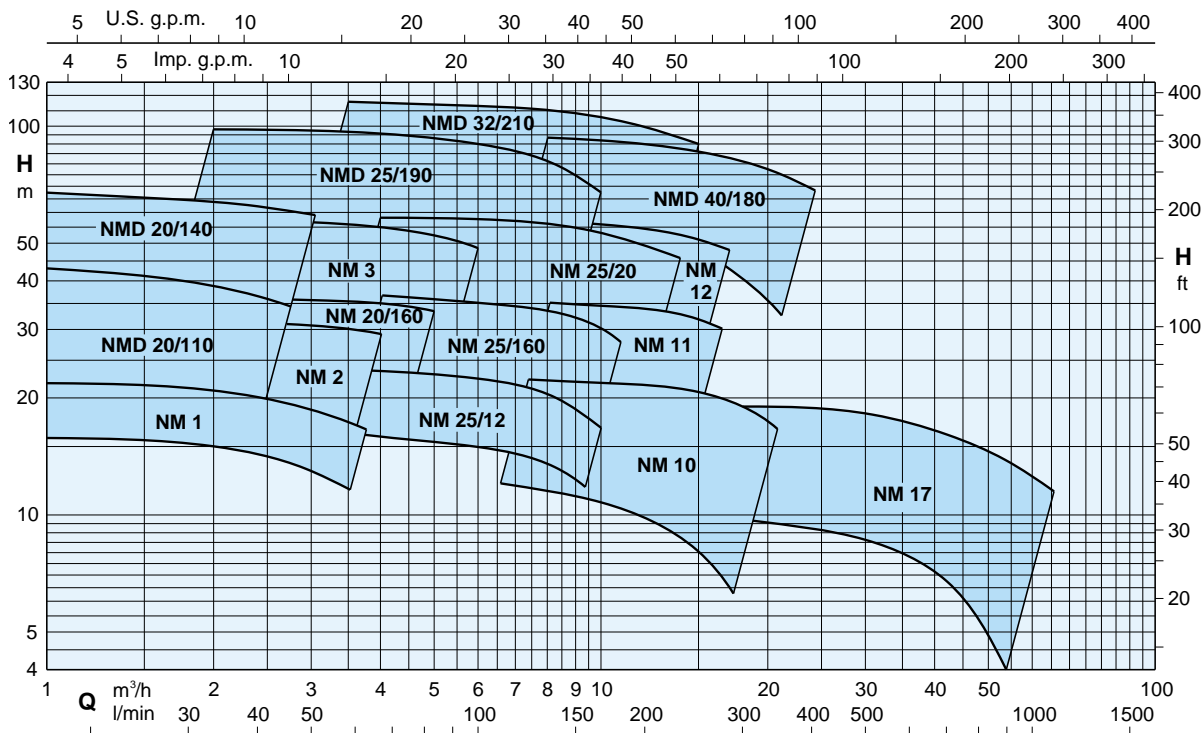

Performance $n \approx 2900$ rpm

	NM	P ₂		Q m ³ /h																
		kW	HP																	
				l/min	1	1,2	1,5	1,89	2,4	3	3,6	4,2	4,8	5,4	6	6,6	7,5	8,4		
					16	20	25	31,5	40	50	60	70	80	90	100	110	125	140		
	NM 1/AE ●	0,37	0,5	H m	22	21,5	21	20,5	20	19	17,5	15,5								
	NM 2/BE ●	0,55	0,75		27	26,5	26	25,5	25	24	23	22	20							
	NM 2/SE ●	0,55	0,75		31	30,5	30	29	27,5	25,5	23,5	20	16							
	NM 2/AE ●	0,75	1		33,5	33	32,5	32	31,5	30,5	29,5	28,5	27	26	24					
	NMM 3/CE	1,1	1,5			37,5	37,5	37	36,5	36	35	34	32							
	NM 3/CE	1,1	1,5			37,5	37,5	37	36,5	36	35	34	32	30,5*	28,5*					
	NMM 3/BE	1,5	2			42	42	41	41,5	40,5	40	39	37	35*	32*					
	NM 3/BE	1,5	2			47	47	46,5	46	45,5	45	44	43	41,5*	40*	37,5*	33*	26*		
	NM 3/AE	2,2	3			56	55,5	55,5	55	54,5	53,5	52,5	51,5	50*	48*	46*	42*	36*		

B-NM B-NMD I-NMD	NM NMD	P ₂		Q m ³ /h																
		kW	HP																	
				l/min	1	1,2	1,5	1,89	2,4	3	3,6	4,2	4,8	5,4	6	6,6	7,5	8,4		
					16	20	25	31,5	40	50	60	70	80	90	100	110	125	140		
B-NMD 20/110BE ●	NMD 20/110BE ●	0,45	0,6	H m	33	32	31	29	26,5	23	18									
B-NMD 20/110ZE ●	NMD 20/110ZE ●	0,55	0,75		37	36	35	33	30,5	27,5	23	18*								
B-NMD 20/110AE ●	NMD 20/110AE ●	0,75	1		43	42	40,5	39	36,5	33	29	25*								
I-B-NMD 20/140BE	NMD 20/140BE	1,1	1,5		52	51,5	51	50	48,5	47	45									
I-B-NMD 20/140BE	NMD 20/140BE	1,1	1,5		53	52,5	52	51	50	48	46	43,5	40							
I-B-NMD 20/140AE	NMD 20/140AE	1,5	2		57,5	57	56,5	55,5	54	51,5	49	46	43	40	36					
I-B-NMD 20/140AE	NMD 20/140AE	1,5	2		67	66,5	66	64,5	63	61,5	59	57	53,5	50	46					
B-NM 20/160BE ●	NM 20/160BE ●	0,75	1					30,5	30	29,5	28,5	27,5	26,5	25,5	24	22*				
B-NM 20/160AE ●	NM 20/160AE ●	1,1	1,5					36	35,5	35	34,5	33,5	32	30,5	29	27*				

B-NMD, B-NMD I-NM, I-NMD	NM NMD	P ₂		Q m ³ /h																
		kW	HP																	
				l/min	2,4	3	3,6	4,8	6	6,6	7,5	8,4	9,6	10,8	12	13,2	15	16,8		
					40	50	60	80	100	110	125	140	160	180	200	220	250	280		
B-NM 25/125BE ●	NM 25/12BE ●	0,55	0,75	H m	20	19,9	19,8	19,3	18,5	18	17,3	16,3	15*	13,2*	11*					
B-NM 25/125AE ●	NM 25/12AE ●	0,75	1		23,5	23,4	23,3	22,9	22,1	21,7	20,9	20	18,7*	17,1*	15,2*					
B-NM 25/160BE ●	NM 25/160BE ●	1,1	1,5			31	30,7	30	28,5	28	27	26	23							
B-NM 25/160AE ●	NM 25/160AE ●	1,5	2			36,5	36,2	35,5	34,5	34	33,5	32,5	31	28,5*	26*					
I-B-NM 25/200BE	NM 25/20BE	2,2	3			42,5	42	41	40	39,5	38,5	37,5	36	33*	29*					
I-B-NM 25/200AE	NM 25/20AE	3	4			50	49,7	49	48	47,5	47	46,5	45,5	44*	42*	39*				
I-B-NM 25/200SE	NM 25/20SE	4	5,5			59	58,5	58	57,5	57	56,5	55,5	54,5	53	51,5	49*	44,5*	37*		
I-B-NMD 25/190CE	NMD 25/190CE	2,2	3			62	60,5	59	55,5	51	48,5	44	38*							
I-B-NMD 25/190BE	NMD 25/190BE	3	4			76	75	74	70	66	64	60	54	46*						
I-B-NMD 25/190AE	NMD 25/190AE	4	5,5		98	97	96	93,5	90	88	84	79	70*							

	NM	P ₂		Q m ³ /h																
		kW	HP																	
				l/min	6,6	7,5	8,4	9,6	10,8	12	13,2	15	16,8	18,9	21	24	27	30		
					110	125	140	160	180	200	220	250	280	315	350	400	450	500		
	NM 10/FE ●	0,55	0,75	H m	12,5	12,5	12	11,5	11	10	9	7,5								
	NM 10/DE ●	0,75	1		18	18	17,5	17	16,5	16	15,5	14								
	NM 10/AE ●	1,1	1,5		23	23	22,5	22	21,5	21	20,5	19								
	NM 10/SE ●	1,5	2		23,5	23,5	23	22,5	22	21,5	21	20,5	19*	18,5*	16,5*	13*				
	NMM 11/BE	1,5	2		26,5	25,5	25	24	23	22,5	21,5	19,5	17,5							
	NM 11/BE	1,5	2		29,5	29,5	29	28,5	27,5	27	26	25*	22,5*							
	NM 11/AE	2,2	3		35,5	35,5	35	34,5	34	33,5	33	32*	30*							
	NM 12/DE	2,2	3		38	37,5	37	36	35	33,5	32									
	NM 12/CE	3	4		45	44,5	44	43,5	42,5	41	40	38	36*							
	NM 12/AE	4	5,5	57,5	57	56	55,5	55	54,5	53,5	51,5	49*								

Performance $n \approx 2900$ rpm

1

B-NMD I-NMD	NMD	P ₂		Q m ³ /h l/min	5,4	6	6,6	7,5	8,4	9,6	10,8	12	13,2	15	16,8	18,9	21	24
		kW	HP		90	100	110	125	140	160	180	200	220	250	280	315	350	400
B-NMD 32/210DE	NMD 32/210DE	4	5,5	H m	71	69	67,5	65	62,5	58	53	46	37*					
B-NMD 32/210CE	NMD 32/210CE	5,5	7,5		84	83	82	81	79	76	73	69	64*	54*				
B-NMD 32/210BE	NMD 32/210BE	7,5	10		104	103	102	100	98	95	92	88	84*	76*				
B-NMD 32/210AE	NMD 32/210AE	9,2	12,5		114	113	112	110	108	105	103	99	96*	90*				
I-B-NMD 40/180DE	NMD 40/180DE	4	5,5					60	59,5	57	56	53	51,5	48	44	39	34*	25*
I-B-NMD 40/180CE	NMD 40/180CE	5,5	7,5					69	68	67	66	64,5	63	60	57	53	48*	40*
I-B-NMD 40/180BE	NMD 40/180BE	7,5	10					87	86	85	84	82,5	81	78	75	71	66*	59*
I-B-NMD 40/180AE	NMD 40/180AE	9,2	12,5					94	93	92	91	89,5	88	85	82	78	74*	67*

B-NM	NM	P ₂		Q m ³ /h l/min	21	24	27	30	33	37,8	42	48	54	60	66	75	84	96
		kW	HP		350	400	450	500	550	630	700	800	900	1000	1100	1250	1400	1600
B-NM 17/HE ●	NM 17/HE ●	1,1	1,5	H m	9,5	9,2	9	8,6	8,2	7,5	6,7	5,5	3,5*					
B-NM 17/GE ●	NM 17/GE ●	1,5	2		12	11,7	11,5	11,2	11	10,3	9,7	8,5	7*	4*				
B-NM 17/FE	NM 17/FE	2,2	3			16	16	15,5	15	14,5	14	13	11,5*	10*	8*			
B-NM 17/DE	NM 17/DE	3	4					18	18	17,5	17	16,5	15,5	14*	13*	11,5*		

NM, NMD Standard construction.
B-NM, B-NMD Bronze construction.
I-NM, I-NMD Stainless steel construction.

P₂ Rated motor power output.
H Total head in m.

● With single-phase motor = NMM - NMDM.
 * Maximum suction lift 1-2 m.
 Tolerances according to ISO 9906, annex A.

Rated currents

P ₁ kW	P ₂		230 V 1~ IN A	IA/IN	P ₂					
	kW	HP			230 V Δ / 400 V Y			400 V Δ / 690 V Y		IA/IN
				IN A	IN A	IN A	IN A	IN A		
0,6	0,37	0,5	3	2,6	0,37	0,5	2,4	1,4		3,8
0,71	0,45	0,6	3,6	2,9	0,45	0,6	2,5	1,5		3,8
0,91	0,55	0,75	4,5	3,1	0,55	0,75	3	1,7		4,7
1,2	0,75	1	5,7	3	0,75	1	4	2,3		5,5
1,6	1,1	1,5	7,4	3	1,1	1,5	5	2,9		5,4
2	1,5	2	9,2	2,5	1,5	2	7,5	4,3		5,2
					2,2	3	9,15	5,3		4,7
					3	4	11,5	6,6		7,8
					4	5,5		9,6	5,5	5,9
					5,5	7,5		12	7	6
					7,5	10		16	9,2	9,3
					9,2	12,5		20	11,5	9,5

P₁ Maximum power input.
 P₂ Rated motor power output.
 IA/IN D.O.L. starting current / Nominal current

Characteristic curves $n \approx 2900$ rpm

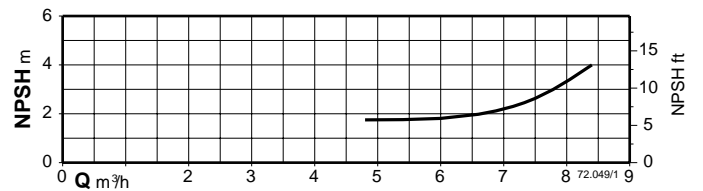
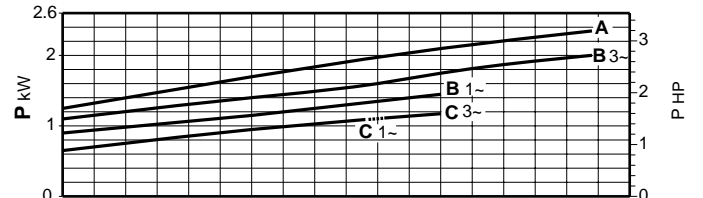
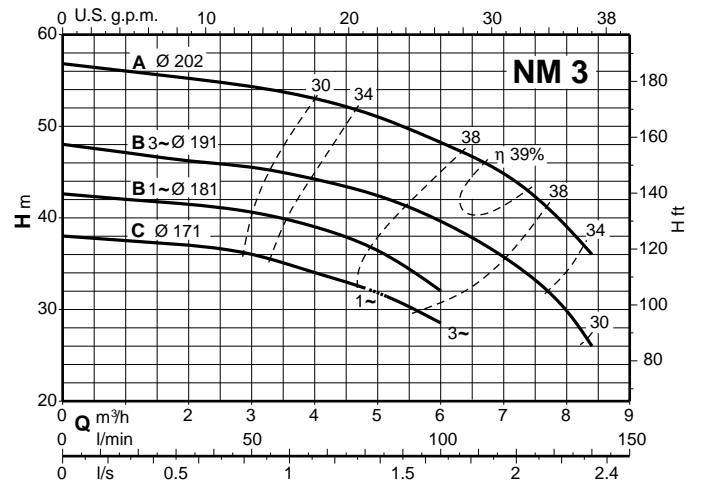
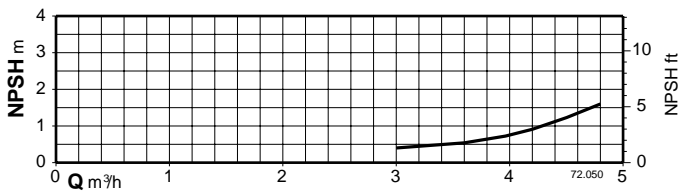
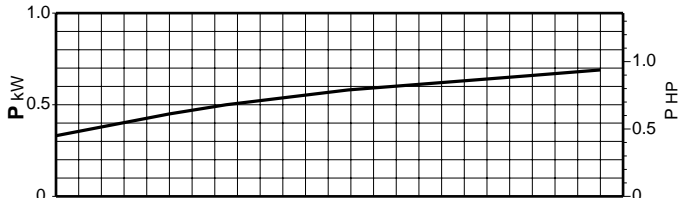
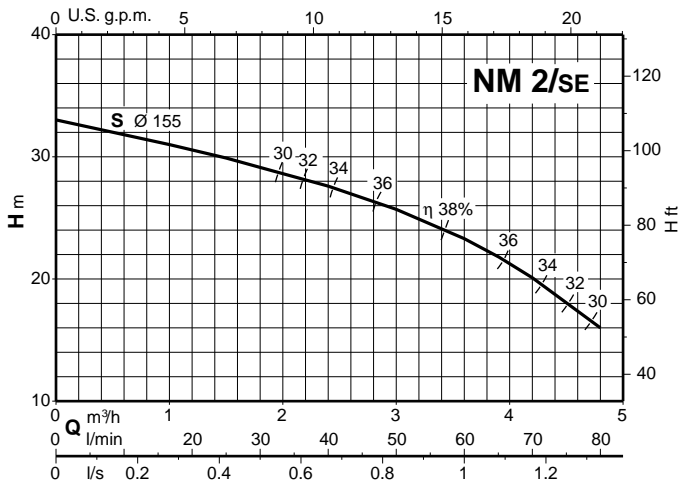
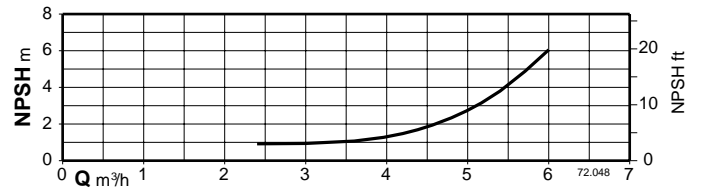
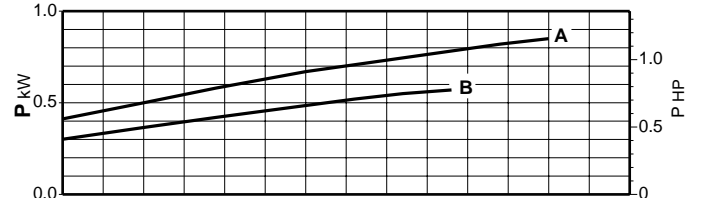
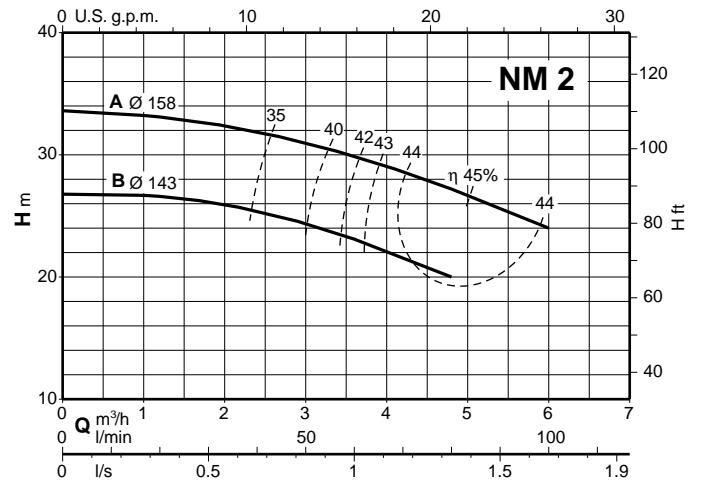
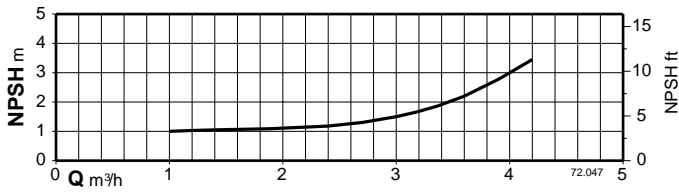
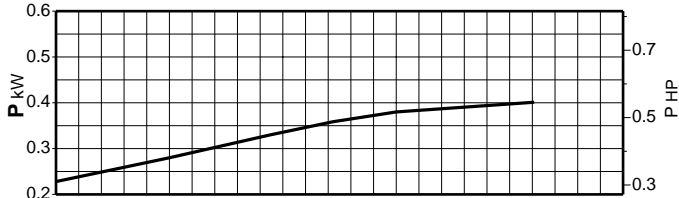
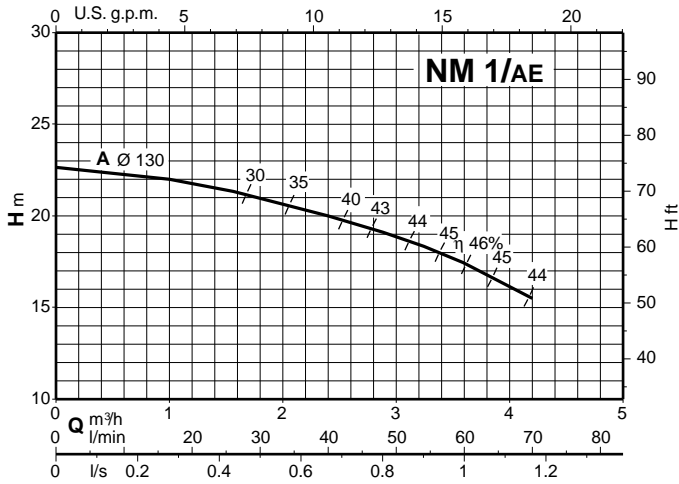

Characteristic curves $n \approx 2900$ rpm

1

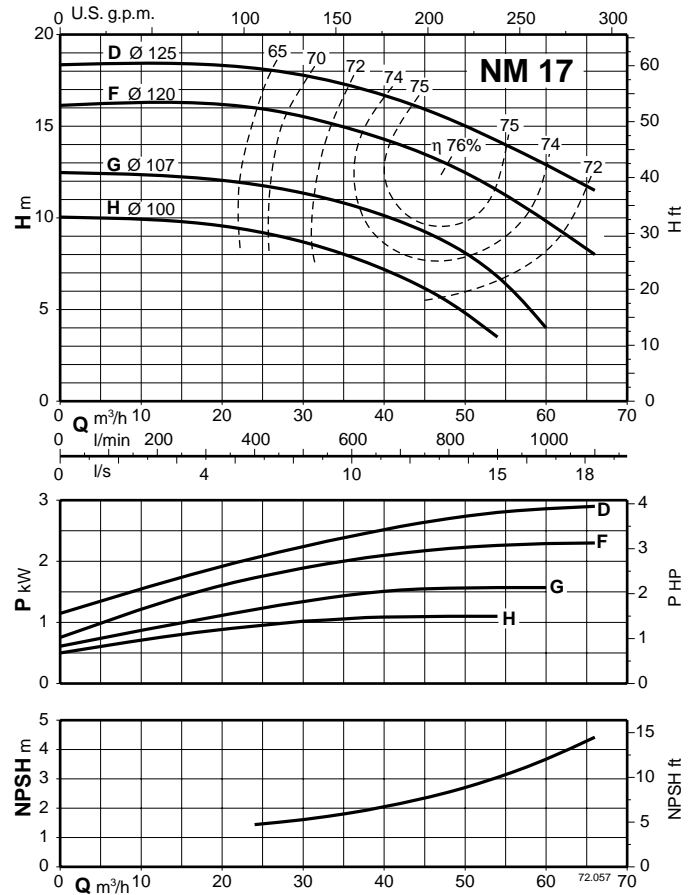
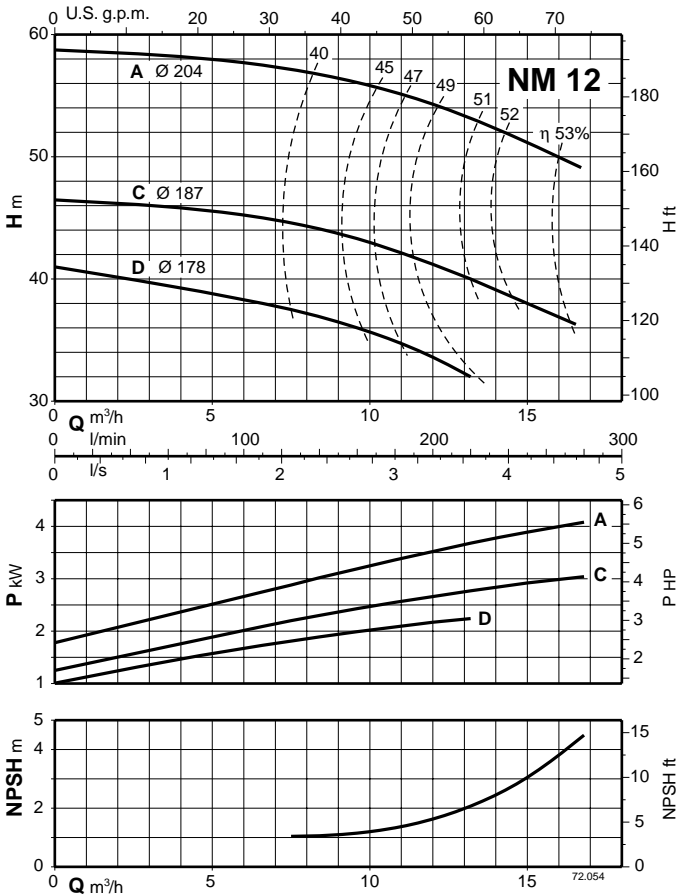
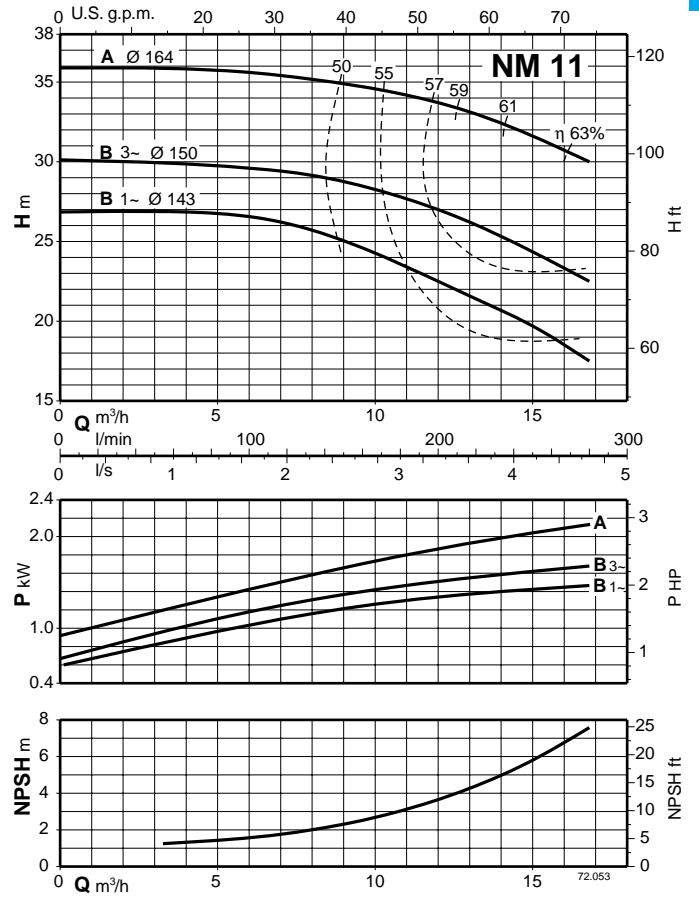
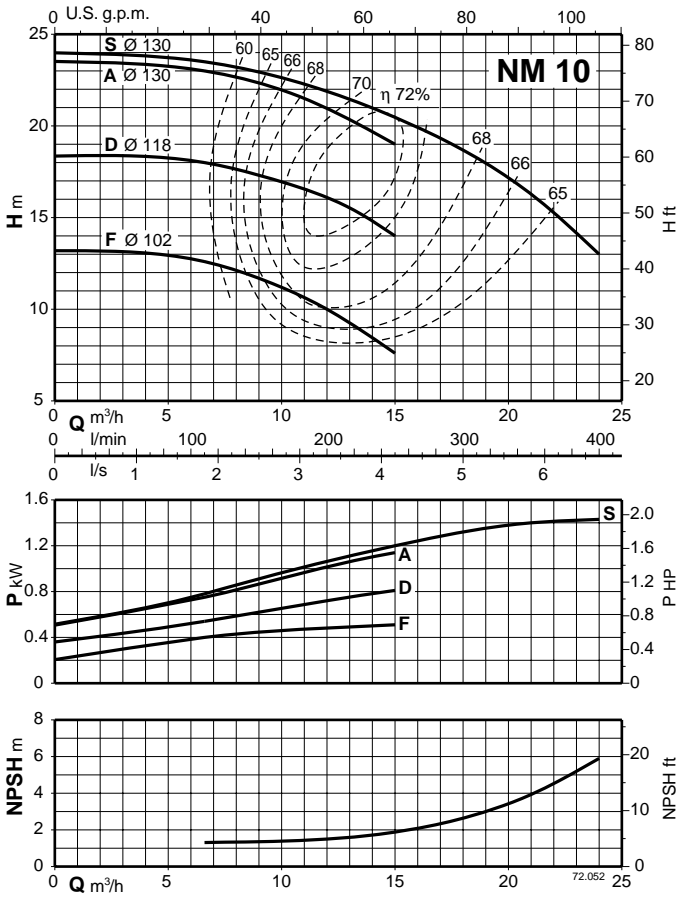

Characteristic curves $n \approx 2900$ rpm

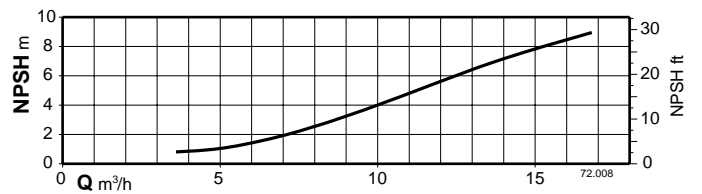
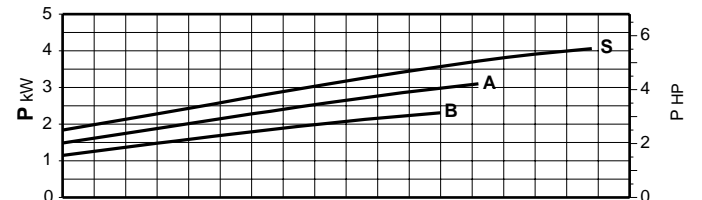
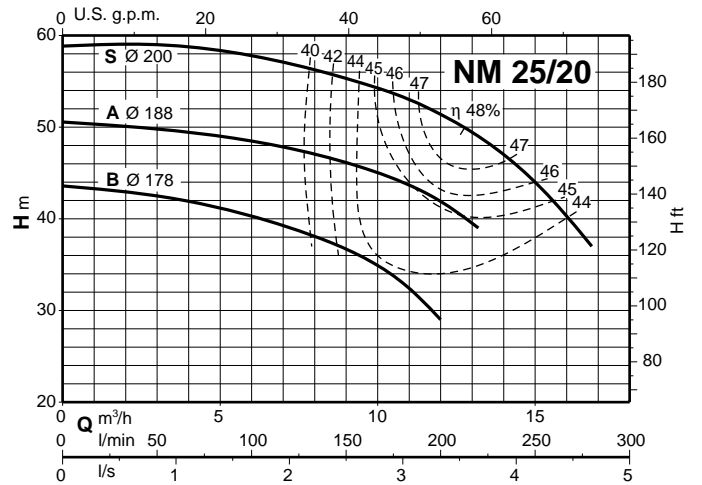
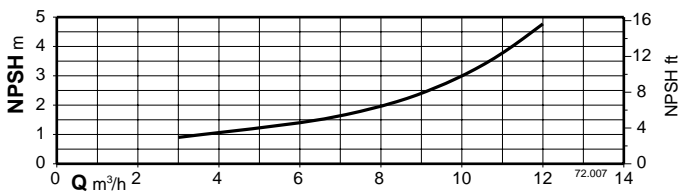
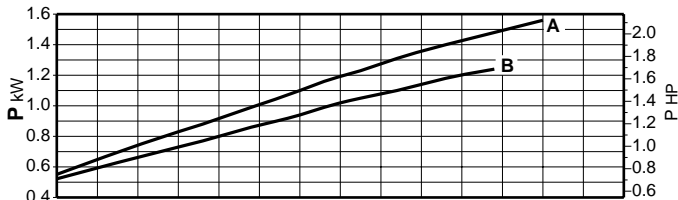
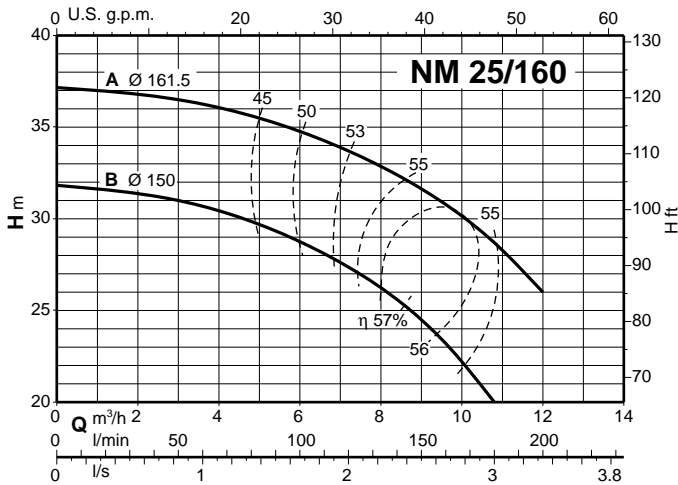
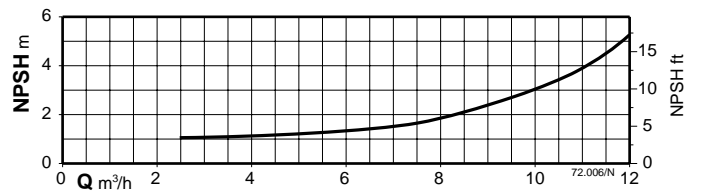
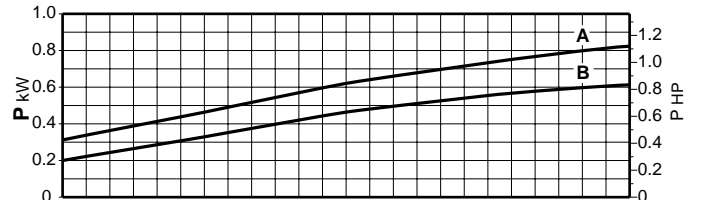
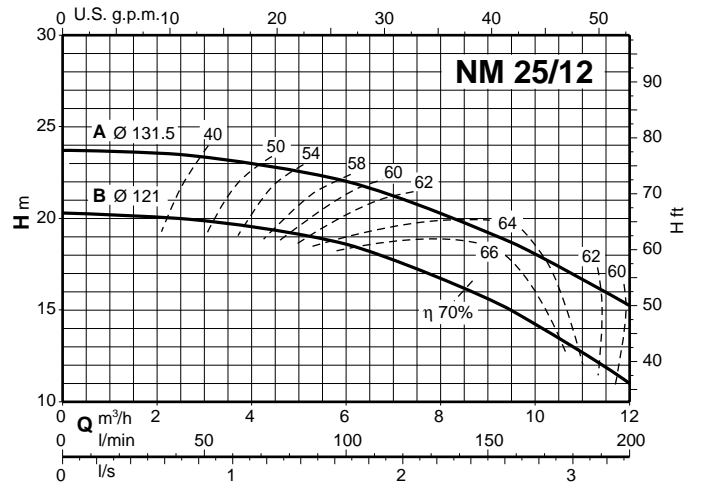
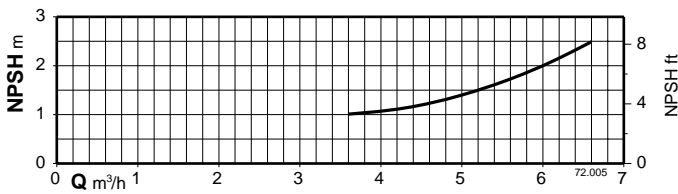
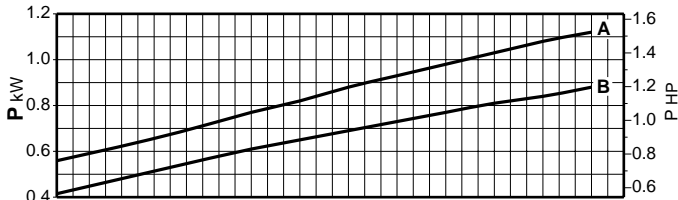
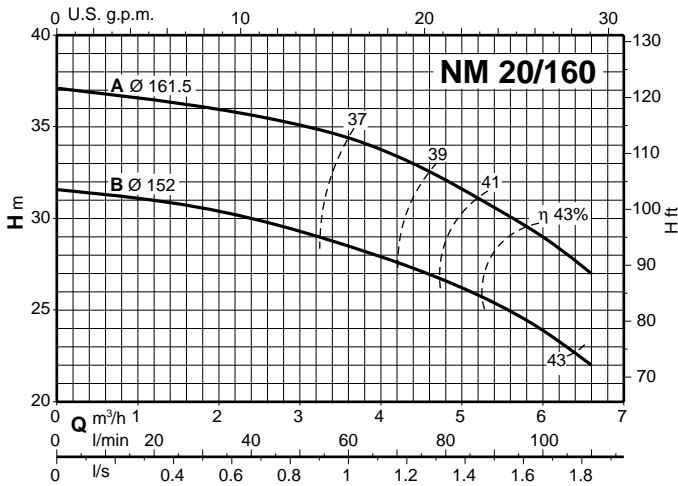

Characteristic curves $n \approx 2900$ rpm

1

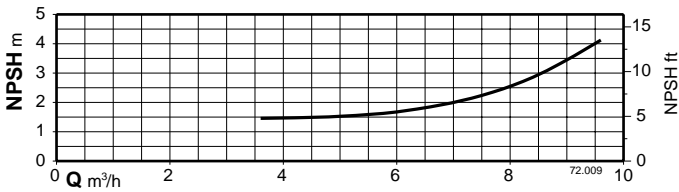
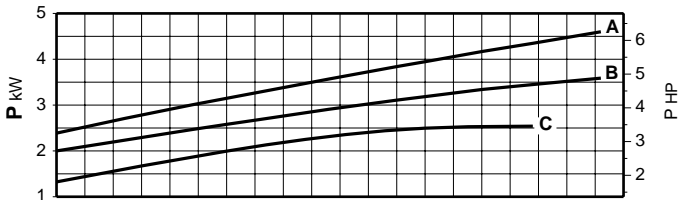
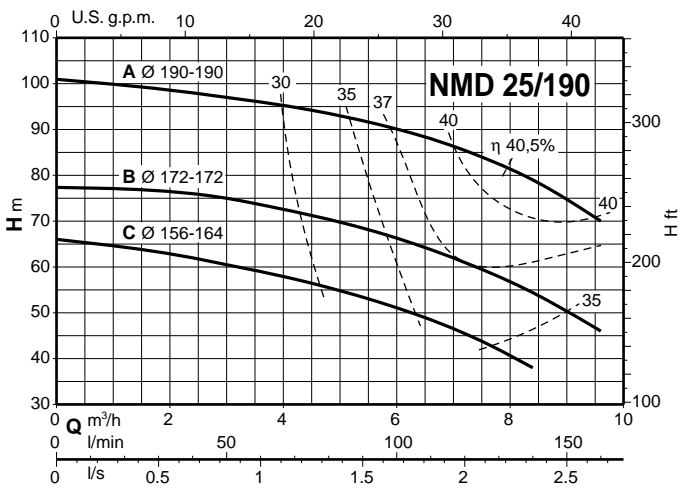
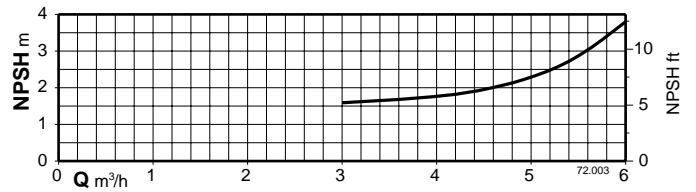
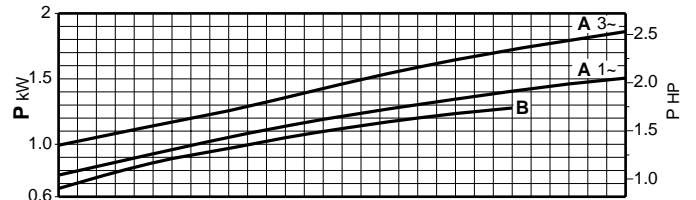
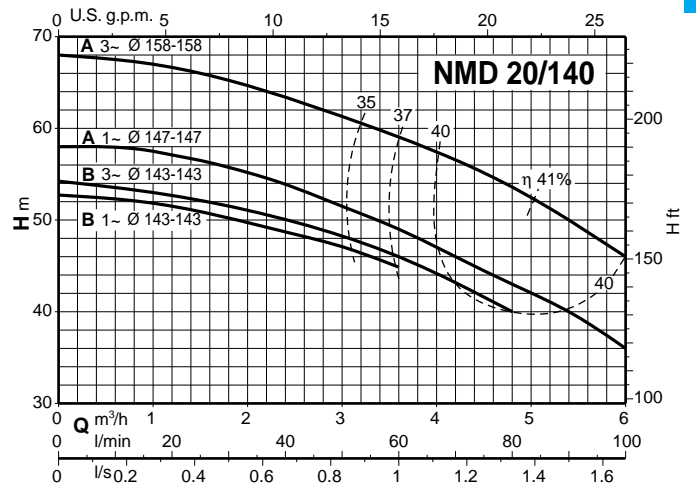
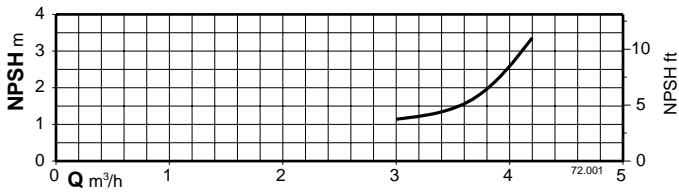
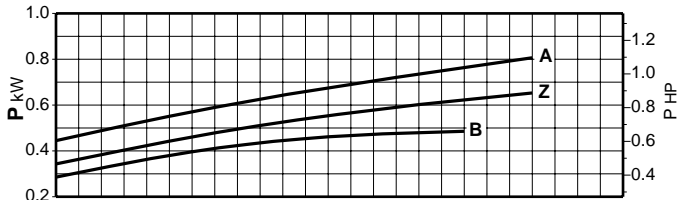
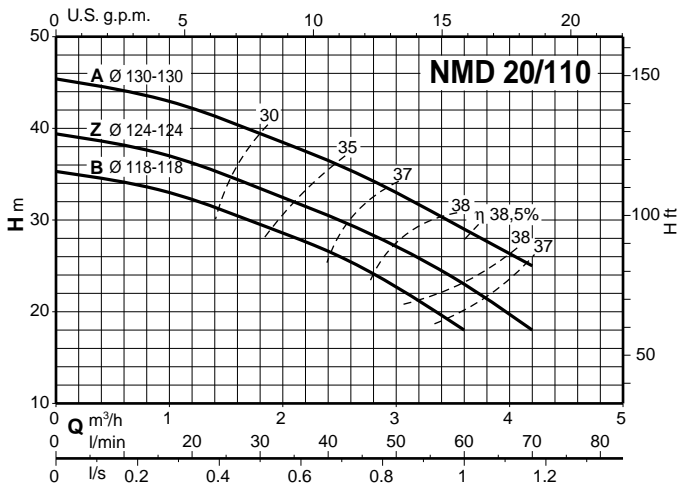

Characteristic curves $n \approx 2900$ rpm

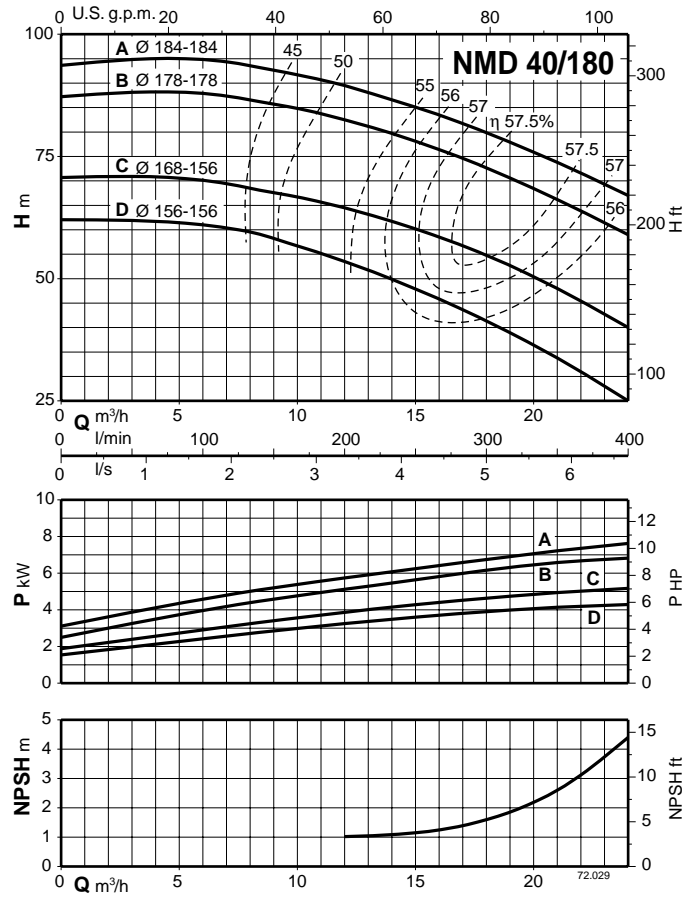
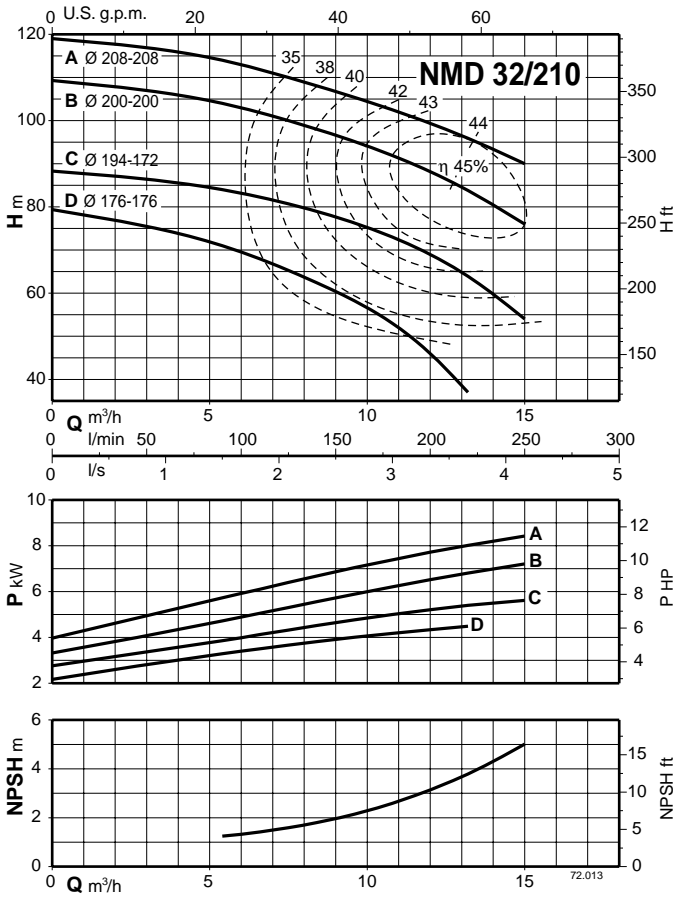

Dimensions and weights

1

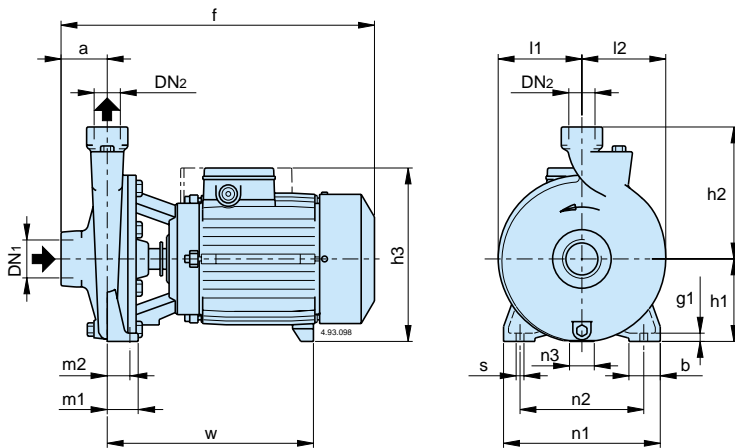

TYPE	NMM kg	NM kg	B-NM kg	I-NM kg
NM 1/AE	8,7	8,6		
NM 2/BE	14	13,1		
NM 2/SE	14,2	13,3		
NM 2/AE	15,1	14,2		
NM 3/CE	24	22,9		
NM 3/BE	26	25,1		
NM 3/AE		26,1		
B- NM 20/160BE	19,9	18,4	21	
B- NM 20/160AE	20,7	19,7	22,5	
NM 25/12BE	13,2	12,3		
NM 25/12AE	14,2	13,3		
B- NM 25/125BE			18,2	
B- NM 25/125AE			18,2	
B- NM 25/160BE	20,4	19,7	22,8	
B- NM 25/160AE	22,5	21,5	24	
NM 25/20BE		28,6		
NM 25/20AE		37,9		
NM 25/20SE		41,7		
I- B- NM 25/200BE			32,7	31
I- B- NM 25/200AE			40,7	38,6
I- B- NM 25/200SE			44,7	42,6
NM 10/FE	19,3	18,5		
NM 10/DE	19,4	18,8		
NM 10/AE	20,2	19,3		
NM 10/SE	22,1	21,5		
NM 11/BE	24,7	24,1		
NM 11/AE		25,1		
NM 12/DE		30,5		
NM 12/CE		39		
NM 12/AE		43		
B- NM 17/HE	23	22,2	29,2	
B- NM 17/GE	24,2	23,2	30,2	
B- NM 17/FE		25,2	32,2	
B- NM 17/DE		33,2	40,2	

B-NM I-NM	NM	DN1 ISO 228	DN2 ISO 228	mm															
				a	f	h1	h2	h3	m1	m2	n1	n2	n3	b	s	l1	l2	w	g1
	NM 1/AE	G 1	G 1	40	261	80	132	176	40	32	170	140	17	35	9,5	77	81	171	10
	NM 2/AE-SE-BE	G 1	G 1	45	305	95	150	203	40	32	190	160	17	35	9,5	87	90	218	10
	NM 3/AE-BE-CE	G 1	G 1	50	375	112	180	222	55	43	245	205	37	45	11,5	110	113	244	12
B-NM 20/160AE-BE	NM 20/160AE-BE	G 1¼	G ¾	53	375	100	150	210	37,5	27,5	190	150	30	38	9,5	102	102	246	10
	NM 25/12AE-BE	G 1½	G 1	56	313	90	140	195	37,5	27,5	170	130	9	38	9,5	85	88	250	10
B-NM 25/125AE-BE		G 1½	G 1	56	380	90	140	200	37,5	27,5	170	130	9	38	9,5	85	88	250	10
B-NM 25/160AE-BE	NM 25/160AE-BE	G 1½	G 1	56	380	100	160	210	37,5	27,5	190	150	30	38	9,5	102	102	246	10
	NM 25/20BE	G 1½	G 1	63	393	125	180	235	45	32,5	245	200	49	45	11,5	125	125	251	11
	NM 25/20AE-SE	G 1½	G 1	63	455	125	180	253	45	32,5	245	200	42	45	11,5	125	125	295	11
I- B- NM 25/200BE		G 1½	G 1	63	405	125	180	235	45	32,5	245	200	49	45	11,5	125	125	263	11
I- B- NM 25/200AE-SE		G 1½	G 1	63	455	125	180	253	45	32,5	245	200	42	45	11,5	125	125	295	11
	NM 10/SE-AE-DE-FE	G 2	G 1¼	63	382	100	150	210	50	35	190	140	30	50	13	90	97	239	14
	NM 11/AE-BE	G 2	G 1¼	70	400	112	170	222	50	35	210	160	37	50	15	103	110	247	14
	NM 12/DE			70	400	132	190	242	50	35	240	190	47	50	15	125	127	247	14
	NM 12/AE-CE	G 2	G 1¼	70	465	132	190	260	50	35	240	190	45	50	15	125	127	300	14
B-NM 17/FE- GE-HE	NM 17/FE- GE-HE	G 2½	G 2½	80	417	112	160	222	50	35	210	160	37	50	14	96	113	257	14
B-NM 17/DE	NM 17/DE	G 2½	G 2½	80	475	112	160	240	50	35	210	160	20	50	14	96	113	295	14

Dimensions and weights

NMD 20/110

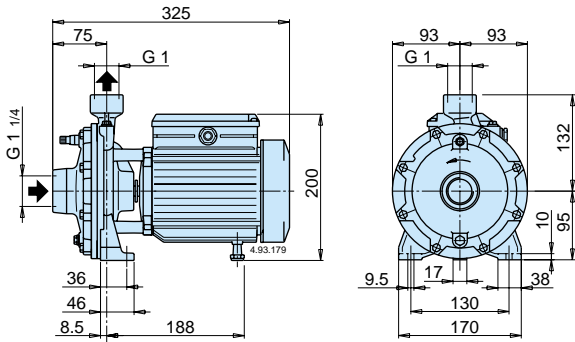

TYPE	NMDM kg	NMD kg	B-NMD kg
B- NMD 20/110BE	13	12,1	13,4
B- NMD 20/110ZE	14	13	14,2
B- NMD 20/110AE	15,1	14,2	17,4

NMD 20/140 NMD 25/190

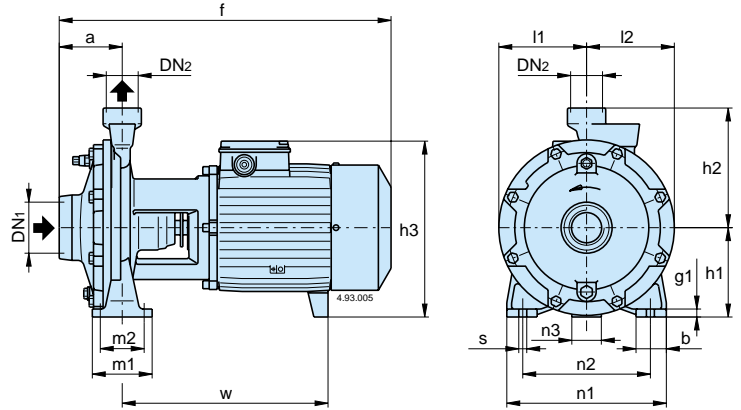

TYPE	NMDM kg	NMD kg	B-NMD kg	I-NMD kg
I- B- NMD 20/140BE	23,9	22,7	25,2	25
I- B- NMD 20/140AE	25,2	24,8	27,6	29,2
I- B- NMD 25/190CE		39	42,7	40
I- B- NMD 25/190BE		46,7	51	48
I- B- NMD 25/190AE		51	55	52

B-NMD I-NMD	NMD	DN1 DN2 ISO 228	mm																
			a	f	h1	h2	h3	m1	m2	n1	n2	n3	b	s	l1	l2	w	g1	
I-B-NMD 20/140AE-BE	NMD 20/140AE-BE	G 1 1/4 G 1	80	410	112	150	222	75	55	200	160	37	50	38	9,5	110	110	256	10
I-B-NMD 25/190CE	NMD 25/190CE	G 1 1/2 G 1		447		250												274	
I-B-NMD 25/190BE	NMD 25/190BE		97	495	140	180	268	100	70	240	190	49	50	14	133	133	306	13	
I-B-NMD 25/190AE	NMD 25/190AE			495		268							49					306	

NMD 32/210 NMD 40/180

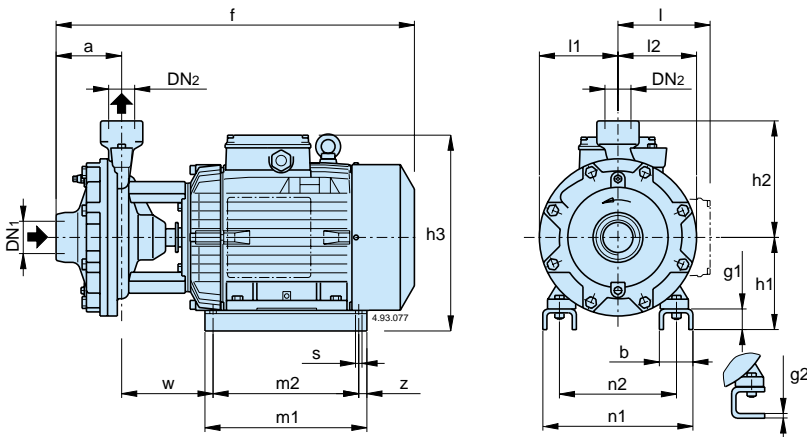

TYPE	NMD kg	B-NMD kg	I-NMD kg
B- NMD 32/210DE	60	66	
B- NMD 32/210CE	70	76	
B- NMD 32/210BE	76,5	82	
B- NMD 32/210AE	99	105	
I- B- NMD 40/180DE	59	65	61
I- B- NMD 40/180CE	69	75	71
I- B- NMD 40/180BE	75,5	81	77
I- B- NMD 40/180AE	97	102	99

B-NMD I-NMD	NMD	DN1 DN2 ISO 228	mm																	
			a	f	h1	h2	h3	m1	m2	n1	n2	z	b	s	l	l1	l2	w	g1	g2
B- NMD 32/210DE	NMD 32/210DE	G 2 G 1 1/4	110	525	155	215	283	205	175	194	140		54	10	-	150	150	139	-	6
B- NMD 32/210BE-CE	NMD 32/210BE-CE			550	150	215	-	280	250	258	190	15	68	12	170	150	108	38	-	
B- NMD 32/210AE	NMD 32/210AE			625	170		355	298	268	286	216		70	12	-	150	150	152	38	-
I- B- NMD 40/180DE	NMD 40/180DE	G 2 G 1 1/2	121	530	155	215	283	205	175	194	140		54	10	-	145	145	133	-	6
I- B- NMD 40/180BE-CE	NMD 40/180BE-CE			555	150	215	-	280	250	258	190	15	68	12	170	145	102	38	-	
I- B- NMD 40/180BE	NMD 40/180BE			630	170		355	298	268	286	216		70	12	-	145	145	145	38	-
I- B- NMD 40/180AE	NMD 40/180AE																			